

THE LIGHT YOU CAN TRUST



# LED SMART GROW LIGHT KINGKONG SPIDER



*Signature*  
Designed by WIP

## DOS

Spectrum for flowering and  
vegetative growth

ช่องทางการสั่งซื้อ



@wipintertrade

wipelectric

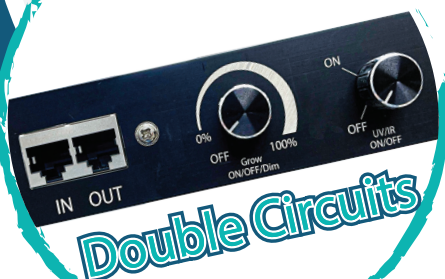

# DOS

## Spectrum for flowering and vegetative growth



# W-DOS1000S 1,000 Watts



### Specification

Model	W-DOS1000S		
Function	Vegetative Stage	Flowering Stage	Vegetative Stage & Flowering Stage
Power Consumption	1,000W		
LED Light Source	OSRAM : DURIS® E 2835		
Operating Temperature	-10 °C to + 65 °C		
Surge Protection	4 kV		
Heatsink	AL Profile		
Driver	1,000W Isolated		
PPE (PAR,400-700nm)	1.85 $\mu\text{mol}\cdot\text{J}^{-1}$		
PPF (PAR,400-700nm)	1,850 $\mu\text{mol}\cdot\text{s}^{-1}$		
PPFD : At 30 cm.	1,564.00 $\mu\text{mol}/(\text{m}^2\cdot\text{s})$	6.30 $\mu\text{mol}/(\text{m}^2\cdot\text{s})$	1,475.60 $\mu\text{mol}/(\text{m}^2\cdot\text{s})$
- RED	22.6%	43.2%	22.6%
- GREEN	73.9%	47.9%	73.9%
- BLUE	3.5%	8.8%	3.5%
Input Voltage	100-240 VAC 50/60Hz.		
Power Factor	>0.95		
Circuits	Double Circuits		
Dimmable	Dimmable		
IP Rating	IP65		
Life Time	25,000 hrs.		
Dimension in mm. (WxLxH)	1,192x1,076x75		
Total Weight (kg.)	17 kg.		
Warranty	3 Years		
Standard			

### Spectrum

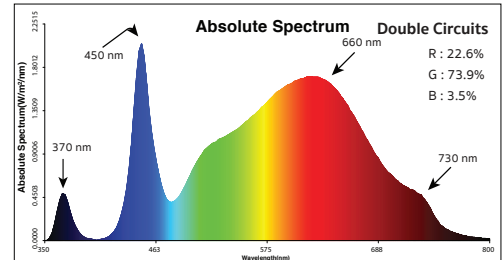
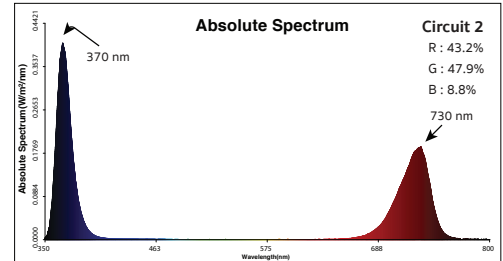
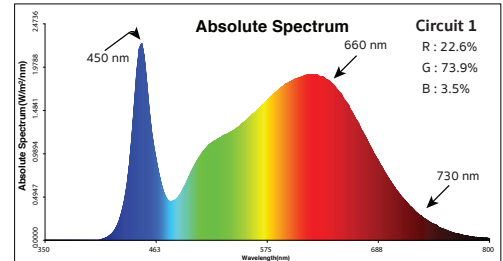

OSRAM : DURIS® E 2835

### DOS : PPFD MAP 1,000W

Unit :  $\mu\text{mol}/(\text{m}^2\cdot\text{s})$

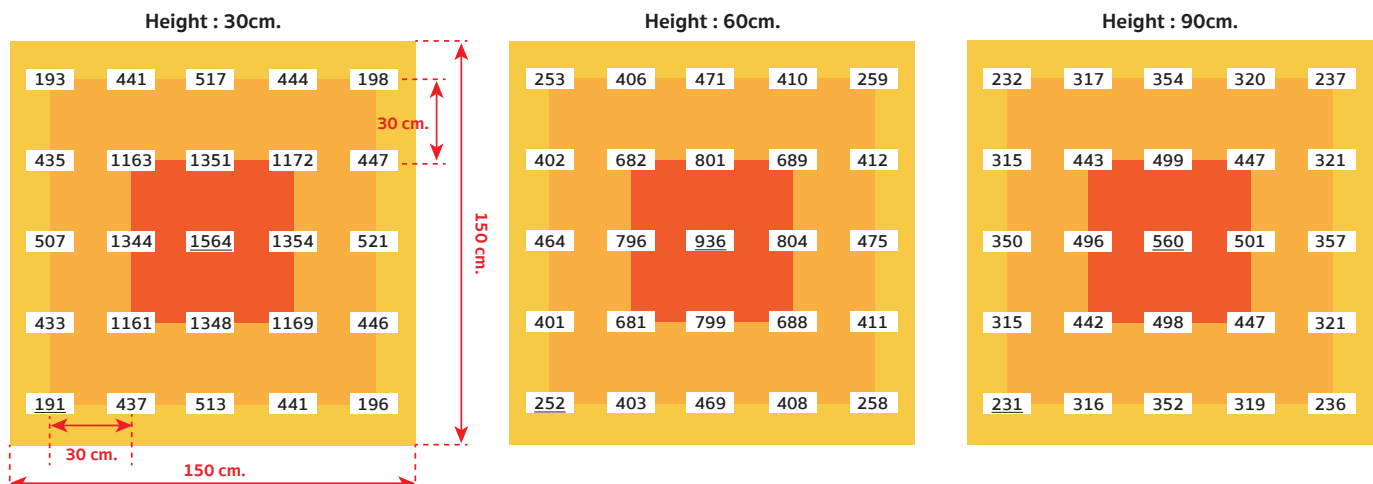

# Dimension in mm.

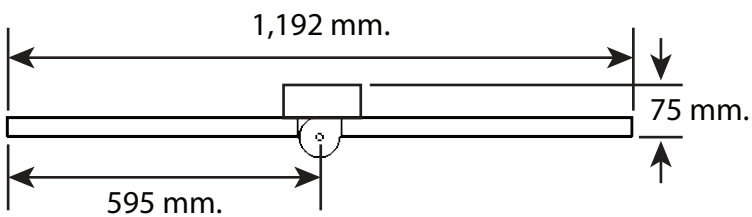
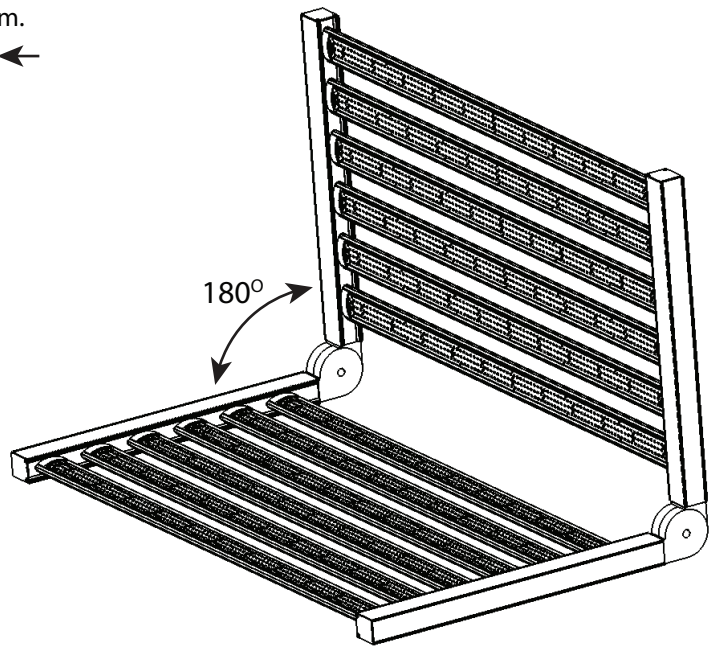
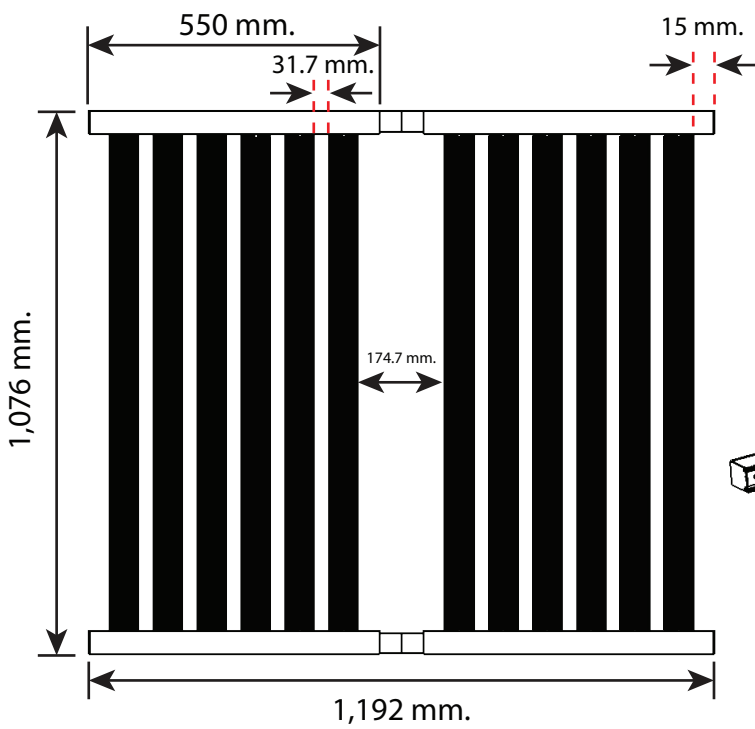

Power	Bar	W	L	H
1,000W	12	1,192	1,076	75

# KINGKONG SMART DIM



Double circuit

**CONTROLLERS DOUBLE CIRCUIT**

Switch	Master / Standalone	Slave
Grow	ON/OFF/Dim 0-100%	OFF
UV/IR	ON/OFF	OFF

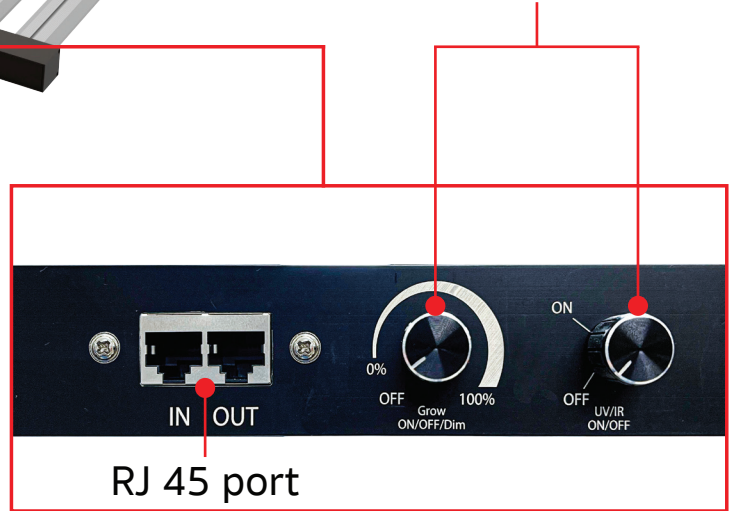

## Wiring Diagram

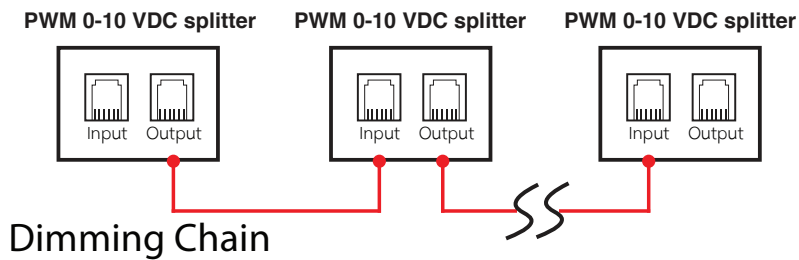
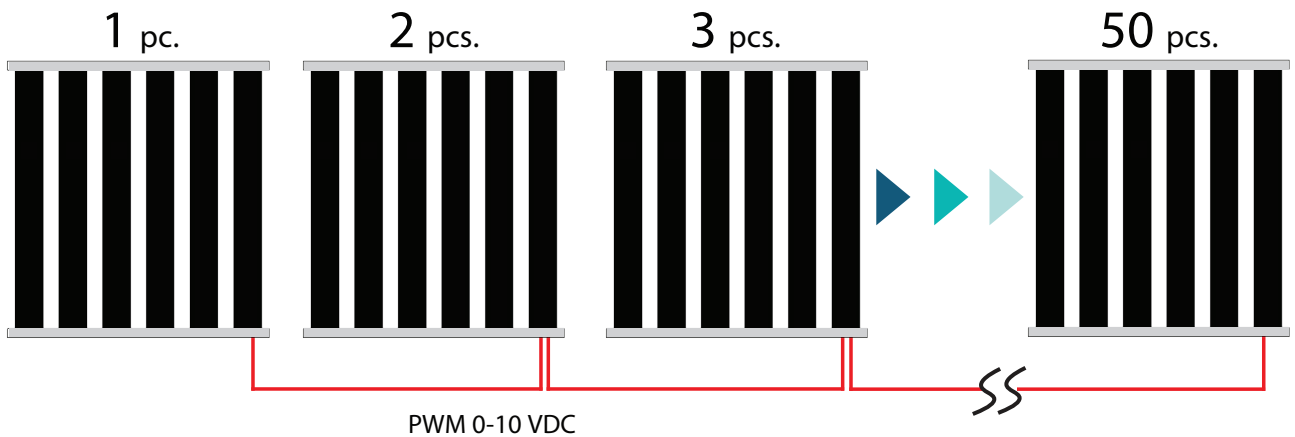

PWM 0-10 VDC Signal length 2 Meters